

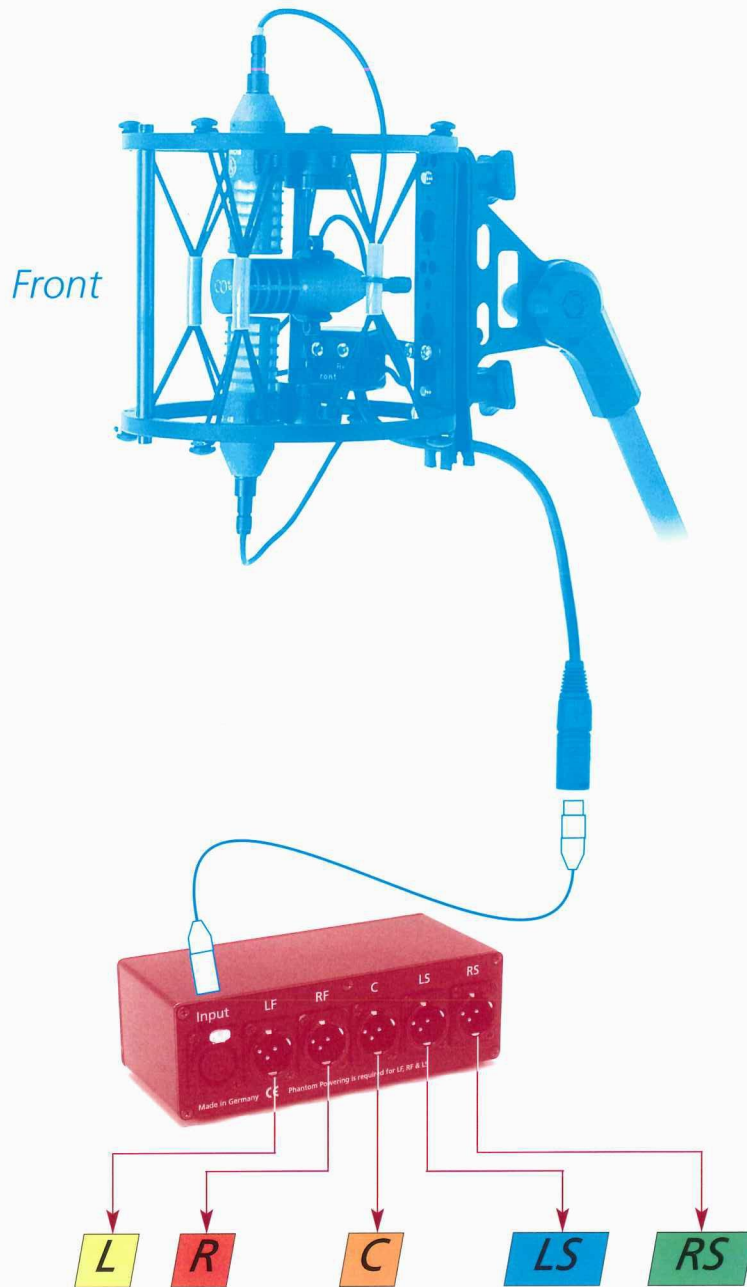

Surround^{11/2006}

Recording Techniques





"IRT Cross" using four SCHOEPS CCM 4 cardioid Compact Condenser Microphones mounted on a SCHOEPS CB 250

Introduction

As every recording engineer knows, the choice of a recording strategy depends on many parameters such as the recording venue, the type of content (musical or otherwise), the time available to install and check the system, the possible need for two-channel compatibility, the availability of a proper monitoring system and many others.

SCHOEPS offers a variety of microphones, mounting accessories and other related equipment for 5.1 surround recording. Depending on the particular situation and purpose, solutions are available which provide maximum practicability and flexibility, along with SCHOEPS quality.

This brochure describes only the most popular setups – those which have been used successfully for years by many sound engineers. In certain cases, however, an individually-designed solution may yield better results. We did not attempt to cover these special cases in the limited space available here, but please feel free to contact us to take advantage our expertise in surround recording, and to request specific proposals.

We are also interested in any further ideas which you may have about surround recording techniques, so that we can remain on top of the knowledge in this field and offer that knowledge to all our customers.

Contact: Surround@schoeps.de

Please visit our Web site at www.schoeps.de for further information about techniques for surround recording.

<i>Contents</i>	Page
OCT	3
OCT Surround	4
IRT Cross / Hamasaki Square	7
Double M/S	8
KFM Surround	11
Decca Tree	12
Overview of Surround Recording Methods	14
SCHOEPS products for Surround	15



OCT (Optimized Cardioid Triangle)

Technique by Günther Theile, IRT

(see www.hauptmikrofon.de/oct.htm)

OCT is a microphone arrangement for recording the front channels for discrete surround sound. It is well designed for obtaining a properly balanced sound image, and has been used successfully as a main microphone arrangement for music recording, ambience recording and other applications in which it is especially important to achieve a balanced distribution of apparent sound sources in the recording. The OCT system was developed by Günther Theile of the IRT. It has been successfully proven in practice, and has repeatedly received very high marks in comparisons of surround recording techniques.

An OCT array consists of three directional microphones whose signals are routed discretely to the left, center and right channels in playback. It can be combined with any of several possible methods for obtaining rear channel signals, thereby creating "OCT Surround" arrangements as shown on the next page.

The particular strength of this setup is its good separation between the "center-to-left" sector and the "center-to-right" sector. For example, sound originating from half-right will be picked up by the center and right-facing microphones, but only very weakly by the left microphone since the null of its supercardioid pattern lies in approximately that direction. Sound from the extreme right will be picked up directly on-axis by the right-facing microphone, then by the center microphone, attenuated 6 dB by the cardioid pattern. Finally it will be picked up in the rear lobe of the left-facing supercardioid, where the attenuation is 10 dB and the signal polarity is inverted. These factors enlarge the listening area, and help to avoid multiple phantom images which would degrade the sound color.

This system also picks up a clean center channel, with front-incident sound being picked up mainly by the cardioid in the center. The left and right microphones, with their high directivity, pick up front-incident sound only at much lower levels (ca. 10 dB attenuation).

The left and right supercardioids receive most of their sound from off axis. This necessitates the use of small-diaphragm condenser microphones which offer consistent frequency response at all angles of sound incidence. SCHOEPS pressure-gradient transducers are optimized precisely for this characteristic.

In OCT setups a pair of the SCHOEPS CCM 41 V (or a pair of MK 41 V capsules on Colette "Active Cables") may offer some advantage over the CCM 41 (or MK 41) in terms of off-axis response at the highest audible frequencies. But the audible difference is slight, and either style of capsule may reasonably be preferred.

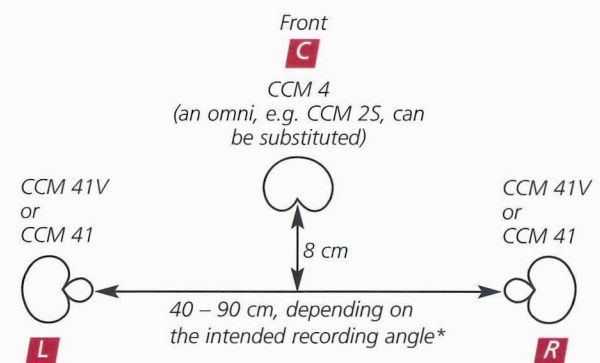
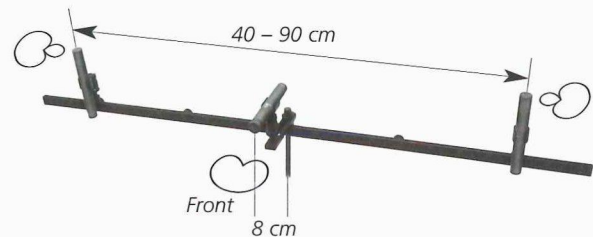

* the range within which the sound sources should be placed, as "seen" by the microphone

Microphone Setup

The preferred setup for OCT uses a forward-facing cardioid for the center channel. For the front left and right channels, two supercardioid microphones are placed at opposite ends of an imaginary line running about 8 cm behind the center microphone. These two microphones should be 40 - 90 cm apart, depending on the required recording angle, and should face squarely outward, away from center (see diagrams above).

All microphones should have the same sensitivity (as in the SCHOEPS CCM/MK 4/41/4V/41V series), or else the preamp gains should be adjusted to compensate.

The following recording angles will result, depending on the distance between the supercardioids:

40 cm: 160°	50 cm: 140°	60 cm: 120°
70 cm: 110°	80 cm: 100°	90 cm: 90°

If there is uncertainty about the desired recording angle, it would be preferable to err somewhat in the direction of greater spacing so as to avoid center-heavy images.

www.hauptmikrofon.de/ima2.htm offers a Java applet called "Image Assistant" which can be used to simulate and envision the localization properties of any stereophonic recording method, including OCT.



OCT 2 setup: The center-channel microphone is shifted forward

OCT 2

Each type of surround setup has particular advantages and disadvantages. For example, the "Decca Tree" is well known for its outstanding reproduction of the spatial qualities of the recording environment, while OCT is generally considered the best system for natural and balanced distribution of sound sources. This behavior has a well-understood theoretical basis, and the reasons for it can be found. Given this knowledge, it becomes possible to combine the advantages of different surround systems.

This has been done in the development of the OCT 2 setup. It is similar to OCT, except that the center microphone is shifted forward by 40 cm instead of only 8 cm. This increases the microphone distances, thus reducing inter-channel correlation. The result has more resemblance to a spacious "Decca Tree" type of sound. If desired, all the localization capability inherent in the OCT system can be maintained by introducing a corresponding 1 ms delay in the center channel signal.

The OCT 2 system can be set up by using a SCHOEPS MAB 1000 stereo bar with the optional OCT 2 extension.

When one system must be used for both 5.1 surround and 2.0 stereo recording, downmix compatibility becomes a prime consideration. OCT 2 offers special advantages in such situations. OCT in general has good downmix properties already, since a sound from any given direction cannot be picked up strongly by all three microphones at the same time. Thus level differences, rather than arrival-time differences, provide the primary directional cues, and this minimizes harmful comb-filter effects in the direct sound when mixing down to two channels. The OCT 2 approach improves downmix quality further with its decreased inter-channel correlation of diffuse-field pickup.

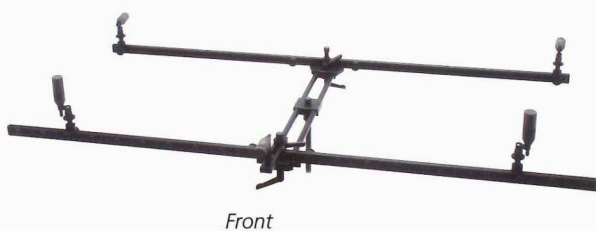

Front

OCT Surround (3/2-Stereo setup)

Technique by Günther Theile, IRT

"OCT Surround" is a well-proven microphone setup for discrete 5-channel surround recording. The OCT front system is supplemented by two cardioids which face rearward to avoid picking up direct sound. Time-of-arrival and level differences between each side's cardioid and hypercardioid pair produce a stereophonic representation of lateral sounds to complement the front stereo image. Lateral reflections, which are important for the perception of the room, are reproduced correctly; this produces a convincing spatial perspective. In playback, the "sweet spot" is large, allowing listeners to move around without the stereo image collapsing.

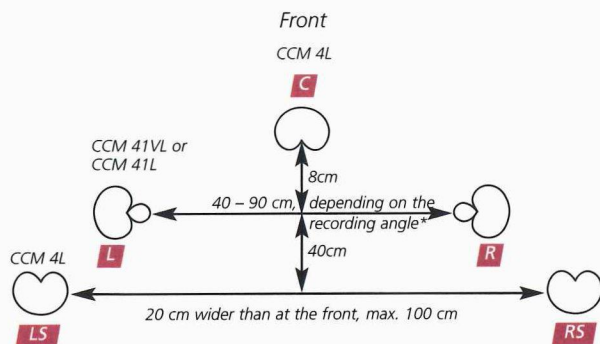

* the range within which the sound sources should be placed, as "seen" by the microphone



OCT combined with other setups

With an OCT Surround setup as described on the previous page, all the microphones for a surround recording can be mounted on a single stand or fixture. As an alternative, particularly if a greater impression of diffuse sound is desired, an OCT front system can be supplemented by other types of "surround channel microphone" setups. These would be located some distance behind the front OCT arrangement.

In particular the Hamasaki square (see diagrams at right and on page 7) has been used successfully in such arrangements. The IRT cross (see page 7) can also be used to good effect. These surround setups should be installed with a minimum distance from the OCT front system, to avoid the comb filtering which would be caused by double pickup of the sound.

In order to keep the necessary imaging of lateral reflections, signals from a four-channel surround setup can be discretely routed to the left, right, left surround and right surround channels.

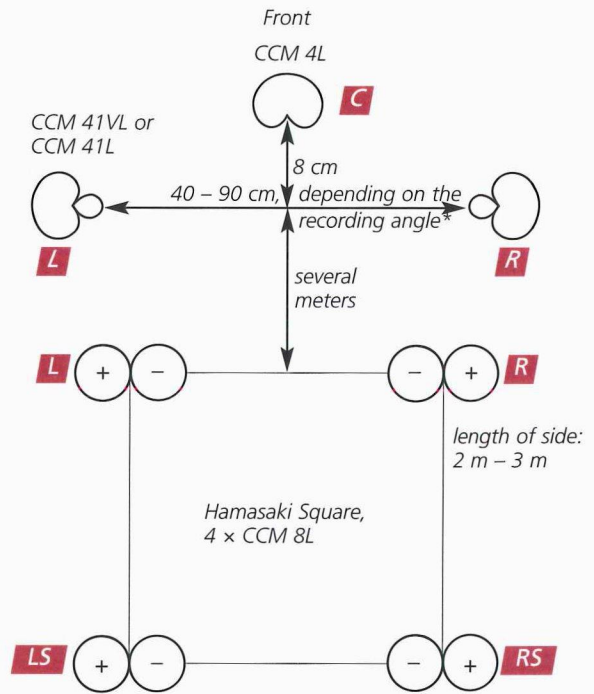

Low frequency augmentation

The bass response of the front left and right microphones in an OCT array can be extended considerably by adding low-frequency signals from a pair of omnidirectional condenser microphones (pressure transducers) such as the SCHOEPS CCM 2. These should be placed within about one meter of the corresponding directional microphones to prevent phase conflicts; they can be attached to the MAB 1000 mounting bar with the MC-MAB accessory as shown at right.

The SCHOEPS LP 40 in-line active filter allows the signals from the omnidirectional microphones to be mixed with those from the supercardioids, with a resulting response that will be substantially flat down to the lowest audio frequencies.

It is also possible to use a single omnidirectional microphone instead of a left-right pair, splitting its signal after the LP 40 filter and mixing it into both the left and right front channels simultaneously. However, the signals at the lowest frequencies will then be mono, and the resulting spatial impression will not be as lively or interesting.

David Griesinger (Harman/Lexicon) has proposed that L and R bass signals be decorrelated by using widely spaced pressure transducers. At low frequencies this would increase the low-frequency pickup in general while accentuating the difference between L and R channels, increasing the sense of spaciousness.

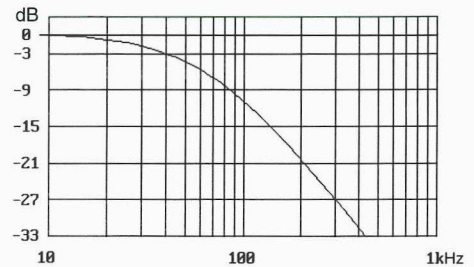

LP 40 low-pass filter

Frequency response curve of the LP 40

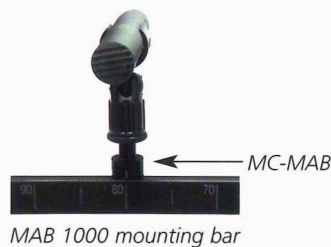

MAB 1000 mounting bar

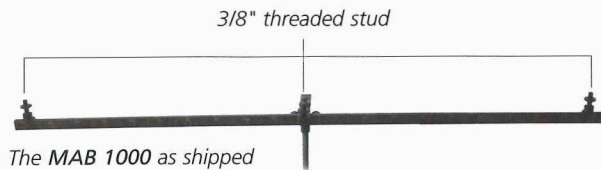

Mechanical Accessories for OCT

MAB 1000 Mounting Bar for OCT or A/B Stereo

- for recording the three front channels for surround
- can also be used for A/B stereo
- OCT recording angle: 90 - 160°
- possible distance between microphones: 4 - 100 cm
- can be expanded for five-channel OCT Surround

This 1-meter-long mounting bar has 3/8" threaded attachments for three stand adapters or shock mounts (not included). Each side of the bar is engraved with markings every 2.5 cm so that distances of 5 cm, 10 cm, 15 cm, etc. can easily be set between the two outer microphones.

Recommended stand adapters or shock mounts:
SG 20 or A 20 for CMC-series microphones;
SGC or AC for CCM-series microphones.

Thread: 3/8"
Length: 1 m
Weight: 500 g

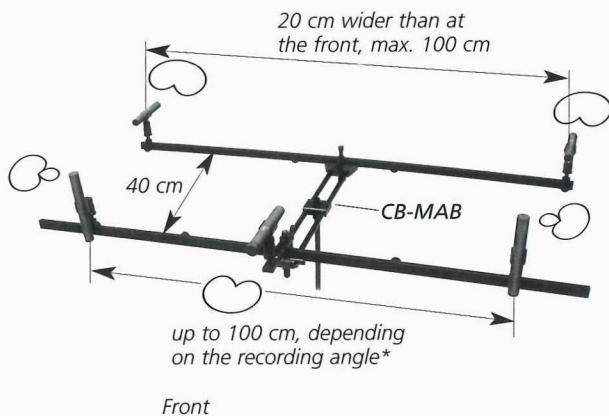

OCT Surround Arrangement with 2 x MAB 1000 + CB-MAB

- for recording five-channel surround
- the simplest and most compact arrangement for surround recording with OCT

This OCT Surround mounting bar set consists of two MAB 1000 mounting bars (one for the three front-channel microphones and one for the two rear-channel microphones), which are held 40 cm apart by a supporting beam with 3/8" threaded attachment.

Accessory (included): KMAB 1000 robust carrying case for the two MAB 1000 mounting bars and the CB-MAB supporting beam.



OCT 2 extension bar for MAB 1000

The OCT 2 extension bar allows the center-channel microphone to be held 40 cm in front of the MAB 1000 mounting bar for OCT recording setups (see page 3).

* The range within which the sound sources should be placed, as "seen" by the microphone. With OCT this is 90 - 160°.



IRT Cross

(also known as "Theile" or "Atmo" cross)
Technique by Günther Theile, IRT

The IRT microphone cross is an arrangement for ambient recording. Its primary characteristic is a transparent and spacious rendering of the acoustic environment. Thus it is widely used in TV/movie/drama/sports recording for surround "atmosphere" recording. It is also useful for picking up room sound when used together with a front channel system such as OCT.

The IRT cross consists of four cardioid microphones. The four microphone signals are discretely routed to the left, right, left surround and right surround channels. The distances are chosen such that the recorded sound will be distributed optimally among the four loudspeakers. This gives a convincing 360° sound image.

Ambient recording does not normally include a center-channel signal; the center channel is more often used for commentary, or for the dialog signal in production sound.

CB --- Mounting Bars for "IRT Cross"

Three special mounting bars are available to enable correct mounting of SCHOEPS compact microphones in an IRT Cross configuration. The CB 200 is the basic model; either cardioids (CCM 4) or supercardioids (CCM 41) can be used with it. (All four microphones should be of the same type, of course.) The larger model CB 250 is for use with cardioids (CCM 4); by creating greater interchannel differences, imaging performance is improved. The smaller model CB 140 is suitable for use with four CCM 41 supercardioids.

Note: The "L" versions of the CCM microphones (with detachable cables) are recommended for greater ease of setup, but the "U" versions or Colette capsules (MK--) on Active Cables (KC--) can certainly be used instead.

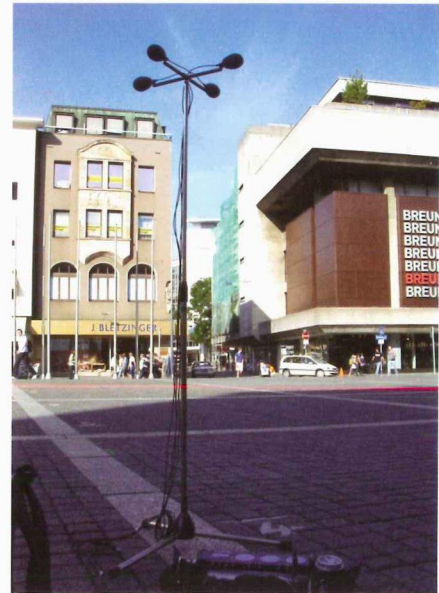

IRT Cross CB 200 with four CCM 4L COMPACT MICROPHONES (cardioids)

Hamasaki Square

Technique by Kimio Hamasaki, NHK

The Hamasaki Square is an ideal setup for picking up the diffuse sound field in a reverberant environment. It complements a setup such as OCT for reproducing spaciousness and envelopment in a surround recording. The four microphone signals are discretely routed to the left, right, left surround and right surround channels.

Since the four figure-8 microphones are aimed "sideways," they effectively prevent unwanted direct sound from entering the surround channels. In live concert situations a Hamasaki Square can be installed above the audience, where the nulls of its figure-8s will help to suppress excessive audience noise.

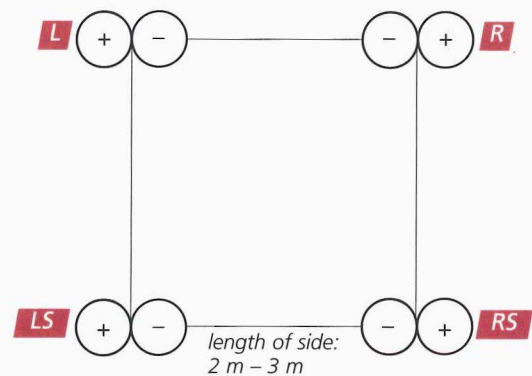

Hamasaki square with four bidirectional microphones

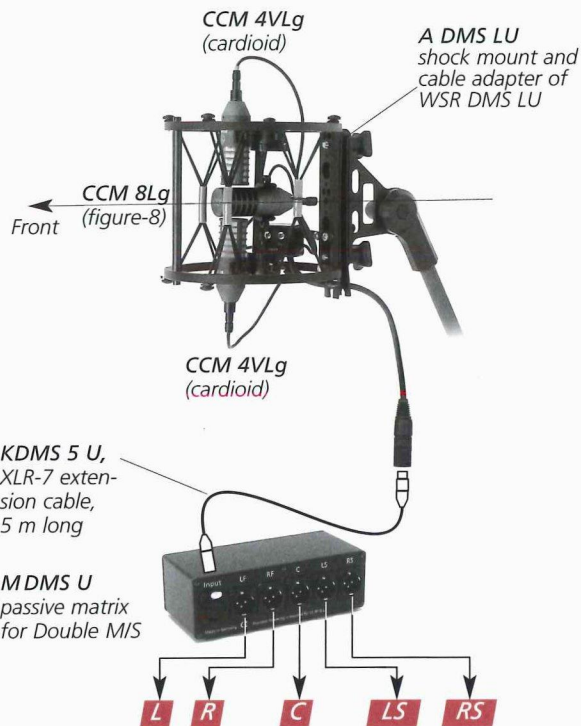

Double M/S set

"Double M/S" Surround [and two-channel stereo]

- requires only three microphones and three recording channels for 5.0 surround
- very small, lightweight array
- can be well protected against wind
- allows post-production processing (matrixing during playback)
- MDMS U decoder can deliver 5.0 surround signals

"Double M/S" is an extended version of the well-known M/S stereo recording technique. Only three microphones and three channels are required for capturing a 5-channel surround recording.

These signals can be decoded either by two ordinary M/S matrixes (which can be facilitated with the DMS Splitter shown below left) or by the MDMS U passive decoder box, which supplies ready-mixed, optimized 4- or 5-channel surround signals.

To make this decoding process flexible and intuitive, a custom VST plug-in for sequencer software will soon be available for download on the SCHOEPS Web site. Please see www.schoeps.de/dmsplugin.htm for further information.

SCHOEPS Double M/S Set

The SCHOEPS Double M/S Set consists of three CCM-L miniature microphones with a special shock mount, a windscreen and a Windjammer. A cable adapter from three Lemo sockets to an XLR-7 output connector is included, as well as an XLR-7 extension cable (5 m long) and the customer's choice of either an MDMS U matrix or a DMS Splitter. The latter is a passive device that simplifies connecting a double M/S array to phantom-powered preamplifiers with matrix circuitry (e.g. 2 x SCHOEPS VMS 5U) or to the inputs of a mixer. It divides the signals from the three microphones into five outputs (the center channel plus the two M/S pairs, with two of the microphones serving dual functions), while preventing any overlap in the phantom powering.

Instead of the CCM 4VL, a CCM 41VL (supercardioid) can be ordered for the front M/S pair.

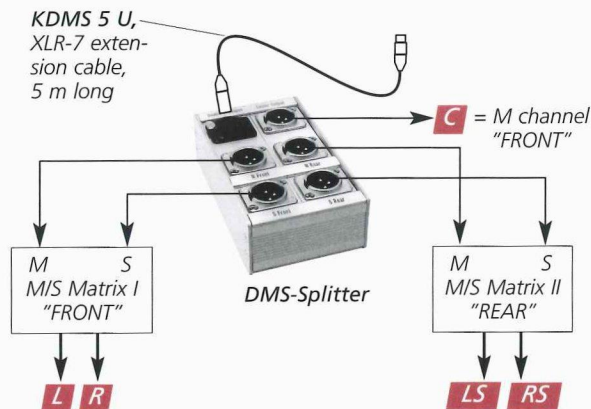

The five channels can also be produced by two external M/S matrixes if the passive DMS Splitter is used.



WSR DMS LU = shock mount with cable adapter and windscreen (150 mm diameter)



WSR DMS LU with Windjammer, a fur cover for enhancing the protection against wind noise



Double M/S Principle

The Double M/S system consists of a front-facing cardioid or supercardioid "mid" microphone, a figure-8 "side" microphone, and an additional rear-facing cardioid. The front- and rear-facing microphones share the signals of the figure-8 so as to form two complete, back-to-back M/S systems. The front-facing M/S pair then provides the three front channels (with the center channel signal being provided directly by its "mid" microphone), while the other system provides the two surround channels. An arrangement of this kind allows flexible post-production processing of the stereo surround image width, just as with two-channel M/S recording. Signals from a double M/S recording are completely compatible with two-channel stereo and even mono mixdown.

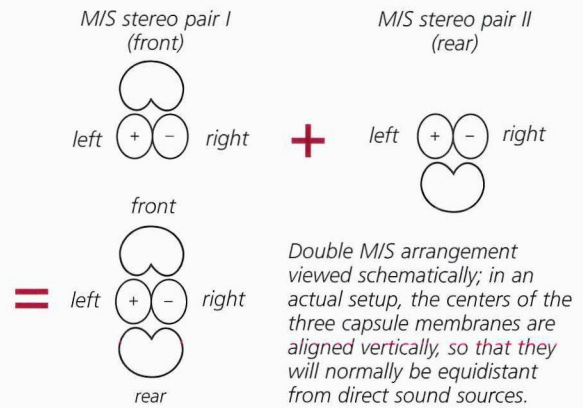

Applications for Double M/S

There are various applications for Double M/S. On the one hand its compactness, the need for only three channels on the recorder, and its flexibility in post-production make it ideally suited for sound recording with ambience pickup in TV/movie/drama productions. But high-profile coincident music recordings for two- as well as multi-channel productions can also be made successfully with a Double M/S setup.

The use of the MDMS U passive decoder box ensures optimal decoding, with balanced distribution of apparent sound sources and minimal crosstalk artifacts.



Double M/S arrangement in a windscreen



Double M/S setup in action



*Double M/S with the **SCHOEPS CMIT** shotgun microphone*

A shotgun microphone can also be the front-facing element as well as the mechanical center for a Double M/S system. It may be mounted on a boom for direct multi-channel capture of production sound, as shown in the photo below with a SCHOEPS CMIT 5 shotgun. The resulting setup provides both a "present" dialog signal as well as multichannel ambience, all of which can furthermore be processed in post-production. This setup requires only three channels on the recorder.

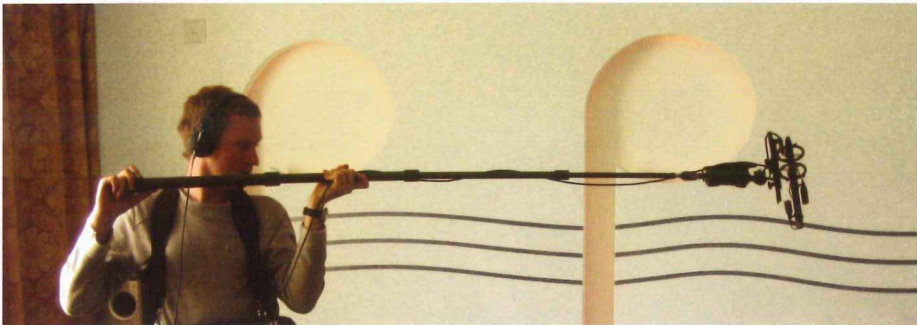

Double M/S setup with shotgun CMIT 5 U

Photo: Courtesy of André Zacher

Advanced two-channel recording with Double M/S

In conventional M/S recording, the relative proportions of "M" and "S" microphone signals going into the matrix can be adjusted to control the directional pattern of the "virtual microphones" – the two imaginary microphones that theoretically would have produced the same left and right signals as those which the matrix is deriving. Unfortunately, any such adjustment will also affect the angle between their axes. The stereo image width and the reverberation balance of the result can't be adjusted independently.

By including the rear-facing cardioid in the decoding process, the polar pattern of the virtual microphones can be varied as before, but now the angle between their axes may be varied freely as well. These two parameters no longer compete with one another.

In the diagrams below, several possible two-channel decodings of a given Double M/S recording are shown. The directional pattern chosen for the virtual microphones in this case was supercardioid, though other directional patterns could equally well have been derived from the same recording. Meanwhile the effective angle between the two virtual microphones can also be adjusted across a wide range. More information about this approach can be found on www.schoeps.de.

By using a double M/S arrangement with one omnidirectional microphone and two figure-8s, superior-quality recordings can be made in Ambisonic "horizontal B-format". An Ambisonic decoder or suitable software can then be used for decoding into surround and/or compatible two-channel stereo.

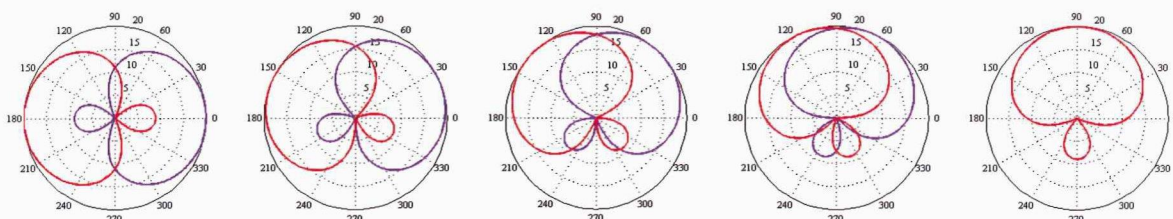



Surround Microphone System by Bruck with KFM 360 and DSP-4 KFM 360

Technique by Jerry Bruck, Posthorn Recordings

This system is based on an idea by Jerry Bruck (see "History" box below). Its distinguishing characteristics are the same which have won many adherents for the SCHOEPS stereo sphere microphone KFM 6: Excellent spatial reproduction and well-balanced, natural sounding localizability of sound sources.

Among other features, the processor offers four-channel microphone preamplification with 48-Volt phantom powering, four-channel A/D and D/A converters, Surround matrixing with rear delay and slope control, and a center-channel signal matrix. All that is required for recording with a KFM 360 DSP System is a digital four-track recorder.

The four recorded microphone signals can be processed and matrixed at any time, purely in the digital domain. Settings for direct/reverberant balance, stereo width, the center-channel matrix, delays and slopes, etc. can be made without loss of quality during studio post-production.

- The complete surround microphone system consists of:
- KFM 360 sphere microphone with SGCKFM suspension for two figure-8s
 - two CCM 8L microphones, attached at the sphere
 - the DSP-4 KFM 360 processor
- These components are also available and usable separately.

Operating Principle

The front and rear channels are derived from the sum and difference respectively of the omnidirectional and figure-8 microphones on each side (see illustration). The four resulting "virtual microphones" will seem to be aimed forward and backward. Their directional pattern can be varied anywhere from omnidirectional to cardioid to figure-8, and the pattern of the rear-facing virtual microphones can even be different from that of the forward-facing ones. Altering the directional pattern alters the sound as well, in ways that are not possible with ordinary equalizers.

This permits an extremely flexible method of adapting to the acoustics of the recording space. If unprocessed signals are recorded directly, the processor settings can be chosen at your convenience during post-production, where better monitoring capabilities may be available.

In this way, the four surround signals left, right, left surround and right surround are produced. The processor provides an optional center-channel signal from a center matrix, plus an LFE signal.

The KFM 360 sphere microphone is a smaller version of the KFM 6, with a wider recording angle (120°) to permit closer miking. The equalization needed for the pressure transducers is included in the processor.



KFM 360
plus 2 CCM 8Lg COMPACT MICROPHONES (figure-8)



DSP-4 KFM 360
processor unit with built-in A/D and D/A converters

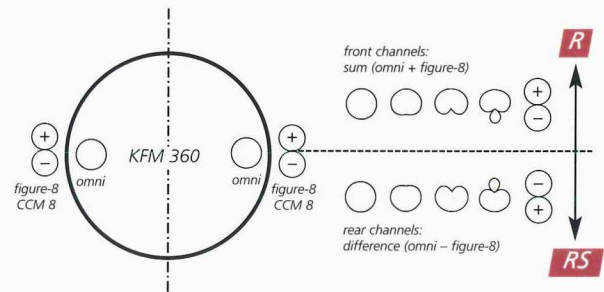

Operating principle: derivation of right (R) and right surround (RS) signals (rough diagram)

History

Jerry Bruck, a well-known American recording engineer, was looking for a way to enhance the directional properties of the KFM 6 sphere microphone for a two-channel stereo production. He came upon the idea of mixing the hemispherical pattern of the pressure transducers with coincident figure-8 microphones so as to emphasize the frontal sensitivity of the arrangement. This was thoroughly successful but revealed itself as a true stroke of luck when a few weeks later, the producer asked about the possibility of making a surround mix at the same time. Mr. Bruck, well known for his fondness for experimentation, decided to treat the omni/figure-8 pairs as M/S pairs, thus obtaining signals for the L/LS und R/RS channels. He was pleased to find that the resulting four-channel mix showed characteristics similar to those which he already valued in two-channel sphere recording.

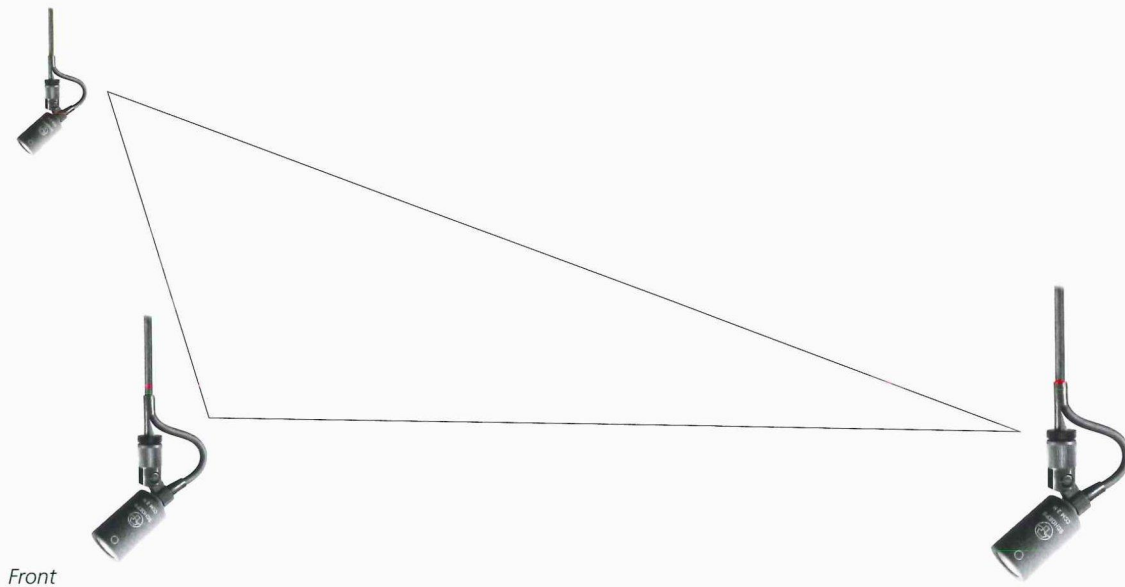

Decca Tree

Omnidirectional microphones are preferred for music recording by many sound engineers. Pure pressure transducers have unique properties which include the ability to reproduce even the lowest audio frequencies with full sensitivity. Stereophonic imaging with omnidirectional microphones depends largely on arrival-time differences, which requires the microphones to be placed some distance apart.

The famed "Decca Tree" microphone arrangement was developed for two-channel recording by engineers of the Decca Record Company in the 1950s. It consists of three omnidirectional microphones in a triangle (see diagram at left). The microphones may be aimed directly forward, or the left and right microphones may be turned outward slightly to provide additional level differences at high frequencies. The signal from the center microphone, reduced 4 - 5 dB in level, is split and mixed equally into the left and right channels. Spot microphones, and "outriggers" farther from the center of larger ensembles, can also be used.

Decca's engineers tried many different microphone types, both omnidirectional and cardioid. Eventually they settled on a special microphone developed by the German NWDR broadcasting organization, based on a small single-diaphragm pressure transducer with diffuse-field equalization. The capsule was built into a sphere of hard material some 40 mm in diameter. The sphere's acoustical effects are discussed on page 13; to obtain them today, many engineers use special accessory spheres designed for small-diaphragm omnidirectional microphones.

For multichannel recording the left, center and right microphone signals are recorded discretely. Surround signals can be obtained either from two additional microphones at a moderate distance from the main microphones, or a setup such as the Hamasaki square or the IRT cross can be used (see page 7).

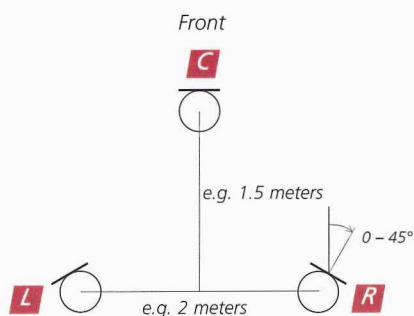

Typical setup of a Decca Tree: The distances among the microphones are not less than 1.5 meters.



The Choice of Microphones

Some parameters depend mainly on the taste of the sound engineer—for example, the choice of microphone. The Decca Tree is very often placed in the midst of a body of sound, e.g. above the conductor of an orchestra, so a microphone with full diffuse-field equalization no longer makes sense. The SCHOEPS MK 2H, an omnidirectional capsule from the Colette (CMC) series, is far better suited; alternatively, the MK 2S may be preferred for slightly more distant placement. Either type may be used with KA 40 or KA 50 accessory spheres.

The SCHOEPS CCM 2H and CCM 2S compact microphones are the direct counterparts of these capsules; either may be used with the KA 40 spheres. (See photos at right for a comparison of the MK 2H and the CCM 2H.) SCHOEPS offers a Decca Tree Stereo set consisting of three matched CCM 2H compact microphones and three KA 40 sphere attachments in a special wooden box.

Cardioid microphones may also be considered; the SCHOEPS MK 4 or CCM 4 would be the leading candidates. A particular "insider tip" is the SCHOEPS wide cardioid MK 21 / CCM 21 or for slightly increased high-frequency response, the MK 21H / CCM 21H. These are ideal when some attenuation of room reverberation is desired, with very good low-frequency sound reproduction.

Variants of the Decca Tree

Since the Decca Tree technique evolved via trial and error rather than being designed on any theoretical basis, it is no surprise that many variations of it exist. Some of these have names of their own, such as the "Polyhymnia Pentagon" (for surround) or the "Omni curtain" (for surround or for two-channel stereo); these are based on the same principle as the Decca Tree. In addition, microphones of other directional patterns are often used in setups with similar geometry, as in the "Fukada Tree" arrangement for surround.

Setting up a Decca Tree

Because of the rather large distances among the microphones, it can be problematic for a single mechanical mounting device to hold an entire Decca Tree arrangement. In any case it is advisable to try different distances and geometries to optimize the setup for each recording environment (e.g. concert hall). Three separate stands can be used, perhaps with Colette "Active Tubes" such as the RC 700, or the microphones can be hung from the ceiling using standard accessories. For the latter, three H 20 or HC cable hangers can be used.



The MK 2H capsule of the SCHOEPS CMC ("Colette") series and the CCM 2H compact condenser microphone which is built with this capsule. These are highly recommended for Decca Tree recording at the miking distances typical of today.

The Effect of Sphere Attachments



Sphere accessories such as the SCHOEPS KA 40 or KA 50 are often used on omnidirectional microphones especially for Decca Tree recording. The sphere attachments introduce an emphasis in the 2 – 5 kHz "presence" region and give a modest increase in directionality while maintaining the full bass response of the pressure transducer.

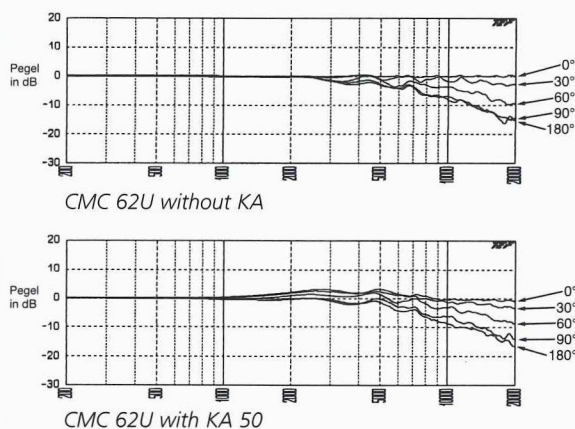

To highlight the effect of the spheres, these graphs use a microphone whose frequency response is perfectly flat on axis. In practice, however, the SCHOEPS MK 2H or MK 2S capsules, or corresponding CCM microphones, would be recommended for Decca Tree arrangements at typical recording distances. (Please note that the KA 50 sphere is too large for use with CCM microphones.)

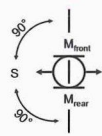
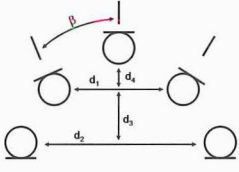
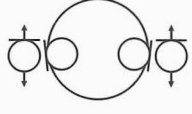
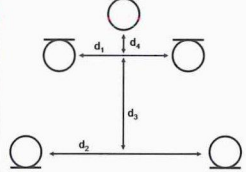

Category of microphone arrangement →	Coincident placement	Near-coincident placement	Microphones separated by an acoustic baffle	Spaced microphones
Principle by which the stereo effect is obtained	level differences	level plus minor arrival-time differences	frequency-dependent level and time differences	arrival-time differences primarily
Typical setups	Double M/S, First-order Ambisonics	OCT Surround, MMAD, INA 5, IRT Cross	KFM 360 system	Decca Tree, Omni Curtain, Polyhymnia Array, Hamasaki Square
Geometry				
Distance between microphones	0 cm	15 - 100 cm	15 - 20 cm	100 - 500 cm
Microphone types used	pressure-gradient transducers (e.g. SCHOEPS cardioid CCM/MK 4, supercardioid CCM/MK 41, figure-8 CCM/MK 8)		SCHOEPS KFM 360/ DSP-4 KFM 360	mainly pressure transducers (e.g. SCHOEPS CCM/MK 2H), also possible with cardioids or wide cardioids
Sonic impression (depending on which microphones are used)	clean, clear, often bright	natural, clean, clear	natural	spacious
			full low-frequency reproduction when omnidirectional microphones are used	
Spaciousness*	often limited; depends on M/S decoding parameters	natural, transparent, good depth	natural	good, enhanced (can become exaggerated)
Localization*	good; depends on decoding parameters	very good	generally fairly good	somewhat indistinct
Size of listening area*	small; better when additional delay is employed	large	rather large	depends on microphone distances
Envelopment*	limited; better when supplemented by an A/B pair	good envelopment possible		
Downmix compatibility	two-channel and/or mono (!)	two-channel compatibility can be good if considered in the array design (e.g. OCT 2)	perfect	potentially good, but this requirement must be taken into account and the setup tested for this purpose

* The statements here are necessarily rather general. The properties of the recording often depend on various parameters which cannot be covered in detail in this list. These properties can furthermore be varied by combining various aspects of different setups.

This list should be considered as a snapshot of current techniques for surround recording. It may be subject to change. It is not intended to create dogmas or "untouchable" recipes for surround recording. The recording engineer and producer are needed more than ever to listen, consider and adjust the results obtained.



Setup	Application	Consists of...
OCT page 3	music recording natural scene recording	<ul style="list-style-type: none"> - 1 x CCM 4 + 2 x CCM 41(V) - stereo bar MAB 1000 - optional CCM 2 + LP 40
OCT Surround page 4	music recording natural scene recording	OCT Surround set: <ul style="list-style-type: none"> - OCT (see above) - 2 x CCM 4 - one additional MAB 1000 - CB-MAB
Double M/S page 8	production sound for TV/movie/drama production coincident music recording	Double M/S set: <ul style="list-style-type: none"> - shock mount + windscreen WSR DMS LU - 2 x CCM 4V + 1 x CCM 8 - XLR-7 cable KDMS 5U - DMS-Splitter or decoder MDMS U or adapter cable AK DMS 3U
IRT Cross page 7	ambience in production sound for TV/movie/drama production ambience recording which can be integrated with L/C/R setup	<ul style="list-style-type: none"> - CB 200 (or CB 250 or CB 140) - 4 x CCM 4
KFM 360 system page 11	natural scene recording	KFM 360 set: <ul style="list-style-type: none"> - KFM 360, 2 x CCM 8 - DSP-4 KFM 360 processor
Decca Tree page 12	music recording	<ul style="list-style-type: none"> - 5 x CCM 2H (or CCM 2 or CCM 2S) - optional sphere attachments for the corresponding CMC microphones - optional cable hanger HC (for CCM) or H 20g (for CMC)
Hamasaki Square page 7	ambience recording together with L/C/R setup	<ul style="list-style-type: none"> - 4 x CCM 8

For further information see:

www.schoeps.de

www.hauptmikrofon.de

(Both sites offer all information in English as well as in German.)

the "Image Assistant" on www.hauptmikrofon.de/ima2.htm

Contact: Surround@schoeps.de

© **SCHOEPS** GmbH, November 2006
Translator: David Satz
Not responsible for errors or omissions.
Subject to change.